

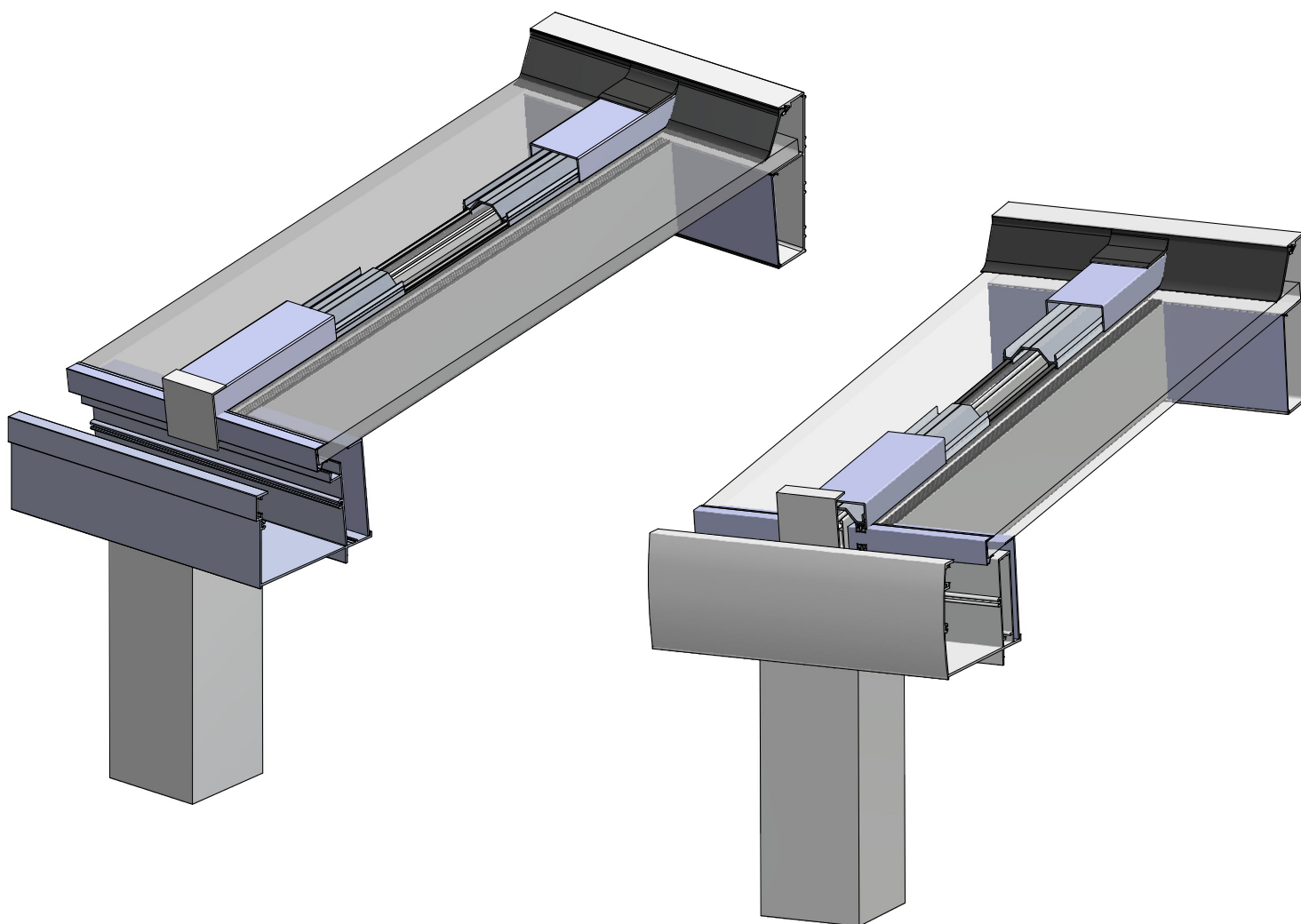

Addendum Catalogue

Profilés toiture porteur non thermique Zelfdragende alu-constructie niet thermisch



DHK Belgique

Rue de Wallonie, 3
B-6200 Châtelaineau
T. 071 24 33 50
F. 071 24 33 55
E. info@dhk.be
W. www.dhk.be

DHK Genk

Kompellaan, 13
B-3600 Genk (Zwartberg)
T. 011 52 36 41
F. 011 52 69 08
E. genk@dhk.be
W. www.dhk.be

DHK Luxembourg





Rue d'Arlon, 22
L-8399 Windhof
T. 27 39 55 62
F. 24 61 13 66
E. info@dhk.lu
W. www.dhk.lu

Profilés toiture porteur non thermique Zelfdragende niet thermisch

Gouttière ronde

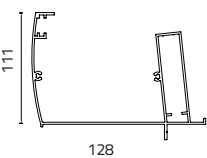
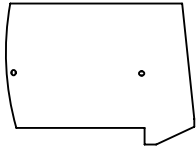
Ronde dakgoot profielen

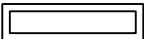
Prix au mètre ou par pièce
Prijs per meter of per stuk

Réf. Ref.	Désignation Benaming	Longueur (m) Lengte (m)	BRUT	Cat. A : 7016, 8019 9001, 9010B	Cat. B : RAL
7354 	Gouttière porteur ronde Zelfdragende ronde dakgoot	2 - 2,5m 3 - 3,5m 4 - 4,5m 5m 6m 7m	30.93 ✓	39.93 ✓	44.26
6054 	Embout de gouttière 7354 Eindstuk goot 7354	pce stuk	6.16 ✓	10.40	11.50
6024 	Jonction de gouttière 6024 Verbinding goot 6024	pce stuk	7.10 ✓	-	-
7348V 	Renfort pour gouttière 7354* Versteving goot 7354*	5m 6m 7m	19.91 ✓	-	-
L100202 	Finition pour gouttière 7354 Afwerking goot 7354	2m 3 - 3,5m 4 - 4,5m 5 6 7	5.20 ✓	7.36 ✓	12.40
6025 	Spacer pour gouttière ronde Afstandhouder afwerking goot (TR2010)	pce stuk	0,31 ✓		

* insertion du renfort dans la gouttière par nos soins : 12,55€ net.







* inschuiven verstevinger in goot : 12,55€ netto

Profilés toiture porteur non thermique

Zelfdragende niet thermisch

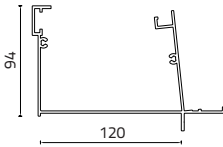
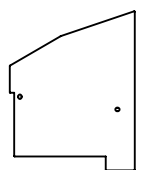
Gouttière carrée

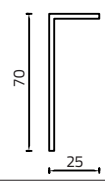
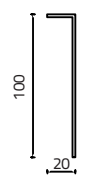
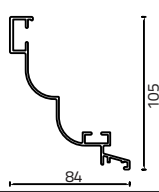
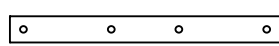
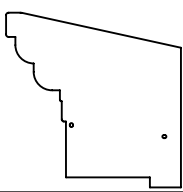



Rechte dakgoot profielen

Réf. Ref.	Désignation Benaming	Longueur (m) Lengte (m)	Prix au mètre ou par pièce Prijs per meter of per stuk		
			BRUT	Cat. A : 7016,8019 9001,9010B	Cat. B : RAL
7348 	Gouttière porteur carrée Zelfdragende goot recht	2 - 2,5m 3 - 3,5m 4 - 4,5m 5m 6m 7m	25.40 ✓	34.23 ✓	38.48
6002 	Embout de gouttière 7348 Eindstuk goot 7348	pce stuk	4.29 ✓	4.29 ✓	6.20
6008 	Jonction de gouttière 7348 Verbinding goot 7348	pce stuk	7.00 ✓	-	-
L70252 	Renfort pour gouttière 7348 Versteving goot 7348	6m	6.02 ✓	-	-
L100202 	Finition pour gouttière 7348 Afwerking goot 7348	2m 3 - 3,5m 4 - 4,5m 5 6 7	5.20 ✓	7.36	12.40
8365 	Rehausse de gouttière Sierprofiel	2 - 2,5m 3 - 3,5m 4 - 4,5m 5m 6m 7m	11.39 ✓	16.18 ✓	18.48
1099 	Jonction de rehausse 8365 Koppeling voor sierprofiel 8365	pce stuk	5.16 ✓	-	-
6019 	Embout de gout. + réhausse Eindstuk goot + sierprofiel	pce stuk	5.63 ✓	7.84	8.87
6026 	Spacer pour gouttière carrée Afstandhouder afwerking goot (TR5030)	pce stuk	0,51		

Profilés toiture porteur non thermique Zelfdragende niet thermisch

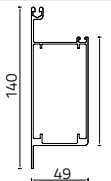
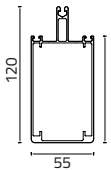
Profils pour plaques ou vitrages

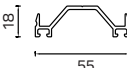
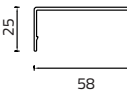
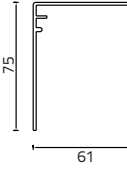
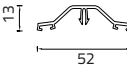
Profielen voor platen of glas

Réf. Ref.	Désignation Benaming	Longueur (m) Lengte (m)	Prix au mètre ou par pièce Prijen per meter of per stuk		
			BRUT	Cat. A : 7016, 8019 9001, 9010B	Cat. B : RAL
7605	 Rive porteur ⁽¹⁾ Randprofiel ⁽¹⁾	2 - 2,5m 3 - 3,5m 4 - 4,5m 5m 6m 7m	18.72 ✓	23.15 ✓	25.29
7604	 Jonction porteur Draagprofiel	2 - 2,5m 3 - 3,5m 4 - 4,5m 5m 6m 7m	19.31 ✓	23.53 ✓	25.55
7606	 Rehausse pour 7604/7605 ⁽²⁾ Verhoogprofiel voor 7604 of 7605 ⁽²⁾	2 - 2,5m 3 - 3,5m 4 - 4,5m 5m 6m 7m	2.63 ✓	-	-
7474	 Profil de fixation à visser Schroefkap	2 - 2,5m 3 - 3,5m 4 - 4,5m 5m 6m 7m	5.27 ✓	-	-
7475	 Coiffe de finition pour jonctions Afdekkap	2 - 2,5m 3 - 3,5m 4 - 4,5m 5m 6m 7m	4.77 ✓	6.99 ✓	8.20
7550	 Coiffe de finition pour rives Randafwerking	2 - 2,5m 3 - 3,5m 4 - 4,5m 5m 6m 7m	8.12 ✓	11.61 ✓	13.29
8484	 Coiffe PVC blanc à clipser pour 7604 PVC wit afdekkap voor 7604	2 - 2,5m 3 - 3,5m 4 - 4,5m 5m 7m	3.25 ✓	-	-
P80 x 5	 Renfort pour 7604, 7605 Versteving voor 7604, 7605	3,5m 4m 5m 6m 7m	9.36 ✓	-	-

(1) Seul le joint 1702 s'utilise comme fermeture
(2) Seuls les joints 1151 et 1702 s'utilisent comme fermeture







(1) Enkel met rubber 1702 als afwerking
(2) Enkel voor rubber 1151 en 1702

Profilés toiture porteur non thermique

Zelfdragende niet thermisch

Joints pour plaques ou vitrages

Dichten voor platen of glas

Réf. Ref.	Désignation Benaming	Longueur (m) Lengte (m)	BRUT	Prix au mètre ou par pièce Prij per meter of per stuk	
				Cat. A : 7016, 8019 9001, 9010B	Cat. B : RAL
2159-4	 Joint 4mm pour 7604, 7605 Dichting 4mm voor 7604, 7605	m	0.95 ✓	-	-
1151.W	 Joint moustache blanc pour 7604, 7606 Witte dichting voor 7604, 7606	m	4.34 ✓	-	-
1151.Z	 Joint moustache noir pour 7604, 7606 Zwarte dichting voor 7604, 7606	m	2.11 ✓	-	-
1702.W	 Joint latéral blanc pour 7605, 7606 Witte dichting voor 7605, 7606	m	3.22 ✓	-	-
1702.Z	 Joint latéral noir pour 7605, 7606 Zwarte dichting voor 7605, 7606	m	3.22 ✓	-	-







Profilés toiture porteur non thermique Zelfdragende niet thermisch

Solin

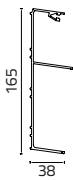
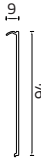
Muurprofiel

Prix au mètre ou par pièce
Prijs per meter of per stuk

Réf. Ref.	Désignation Benaming	Longueur (m) Lengte (m)	BRUT	Cat. A : 7016, 8019 9001, 9010B	Cat. B : RAL
7351	 Solin mural Zelfdragend muurprofiel	2m - 2,5m 3m - 3,5m 4m - 5m 6m - 7m	18.45 ✓	24.71 ✓	27.73
7352	 Finition pour solin mural 7351 Afwerking muurprofiel 7351	2m - 2,5m 3m 5m	5.27 ✓	7.45 ✓	8.51
6003	 Embout pour solin mural 7351 Eindstuk muurprofiel 7351	pce stuk	2.24 ✓	4.44 ✓	6.34
2828.W	 Joint blanc pour profil mural 7351 Witte dichting voor muurprofiel 7351	m	5.97 ✓	-	-
		30m	4.77 ✓	-	-
2828.Z	 Joint noir pour profil mural 7351 Zwarte dichting voor muurprofiel 7351	m	3.51 ✓	-	-
		50m	2.80 ✓	-	-



Profilés toiture porteur non thermique

Zelfdragende niet thermisch

Accessoires

Toebehoren

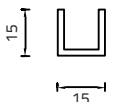
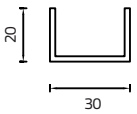
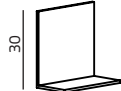
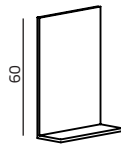
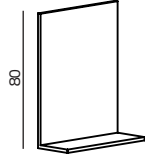
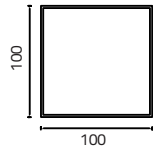
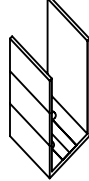
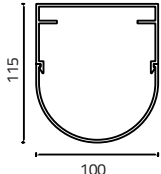
Réf. Ref.	Désignation Benaming	Longueur (m) Lengte (m)	BRUT	Prix au mètre ou par pièce Prijs per meter of per stuk	
				Cat. A : 7016, 8019 9001, 9010B	Cat. B : RAL
U152	 Profil de compensation 16mm U-profiel opvulling 16mm	6m	2.75 ✓	3.93 ✓	6.14
U20302	 Profil de compensation 32mm U-profiel opvulling 32mm	6m	3.04 ✓	6.21	7.24
6005-30	 Arrêt de plaque 30mm Stopplaatje 30mm	pce stuk	0.85 ✓	1.96 ✓	2.93
6005-60	 Arrêt de plaque 60mm pour plaques de 16mm Stopplaatje 60mm voor 16mm dikke platen	pce stuk	2.05 ✓	2.05 ✓	3.01
6005-80	 Arrêt de plaque 80mm pour plaques de 32mm Stopplaatje 80mm voor 32mm dikke platen	pce stuk	2.08 ✓	2.08 ✓	3.04
TC1003	 Poteau 100 x 100mm Koker 100 x 100mm	2 - 2,5m 3 - 3,5m 4m 5m 6m 7m	25.20 ✓	28.80 ✓	37.20
ETC	 Embase pour poteau Voet voor koker	pce stuk	10.25 ✓	-	-
7353	 Cache-gouttière 2-delige koker	2 - 2,5m 3 - 3,5m 4m - 4,5m 5m 6m 7m	35.91 ✓	35.91 ✓	40.23

